

# Installationsanleitung Instructions d'installation Installation Guide

Loopset Spleiss- und Spleisspatchgehäuse BELUGA

Loopset Boîtier à fusionner et boîte à fusionner et à raccorder BELUGA

Loopset Splice Enclosure BELUGA

BELUGA M



14.11.2018

300018

Connect Com AG

Connect Com SA

info@ccm.ch

Connect Com GmbH

info@connectcom.de

Tel +41 41 854 00 00

Tel +41 21 804 66 22

www.ccm.ch

Tel +49 7022 9607 100

www.connectcom.de

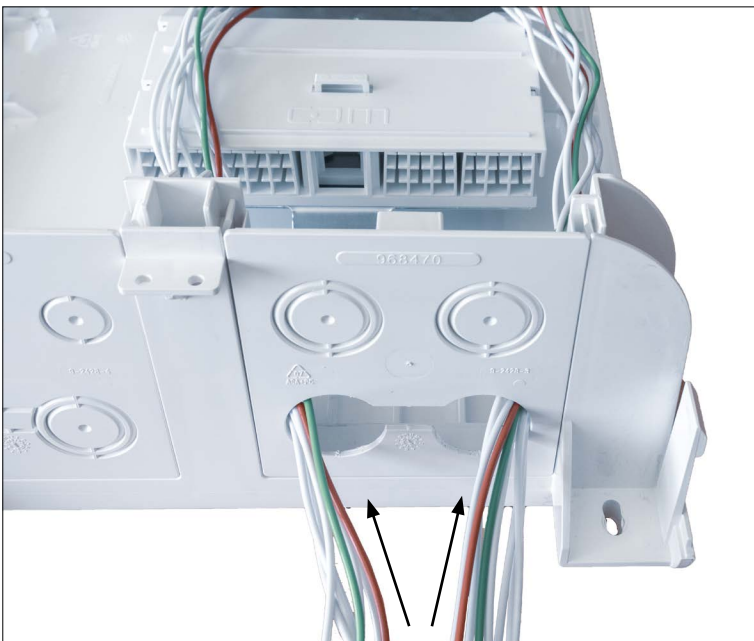
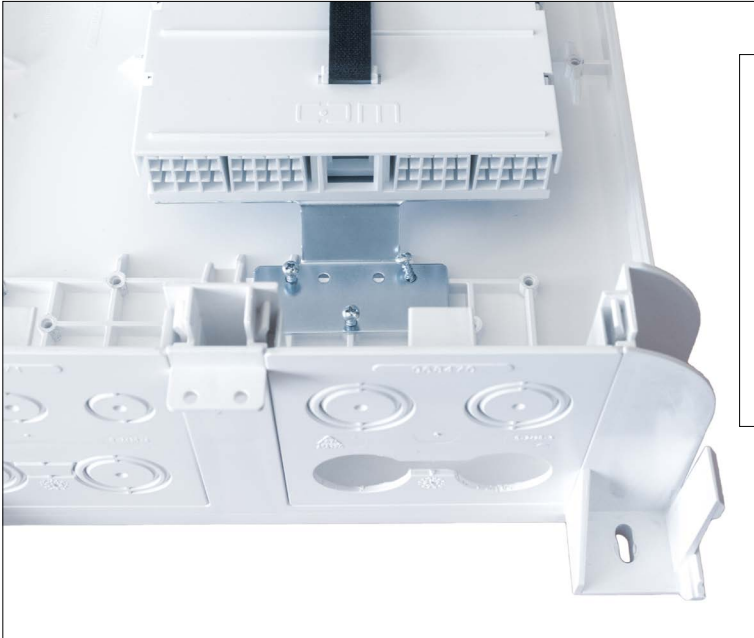

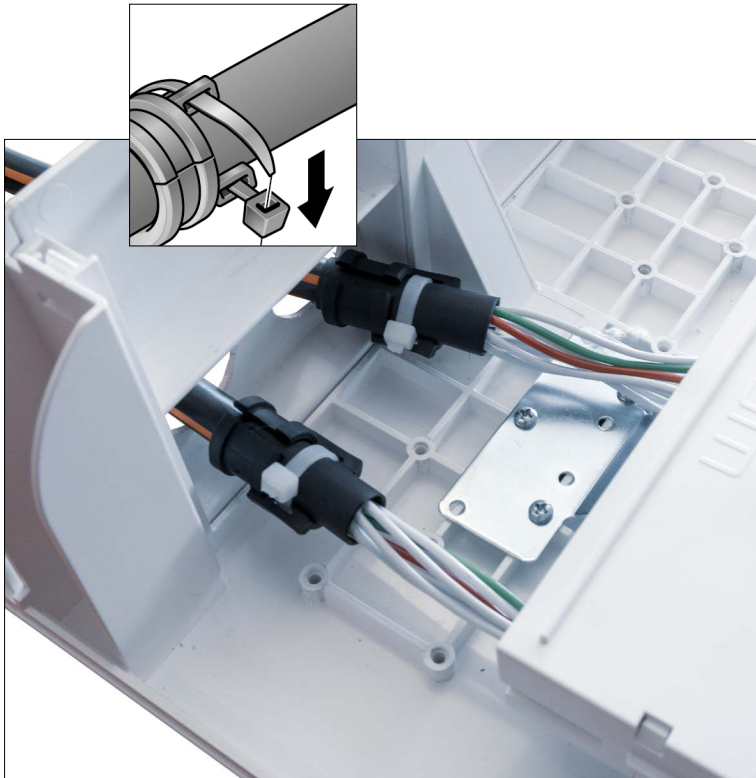

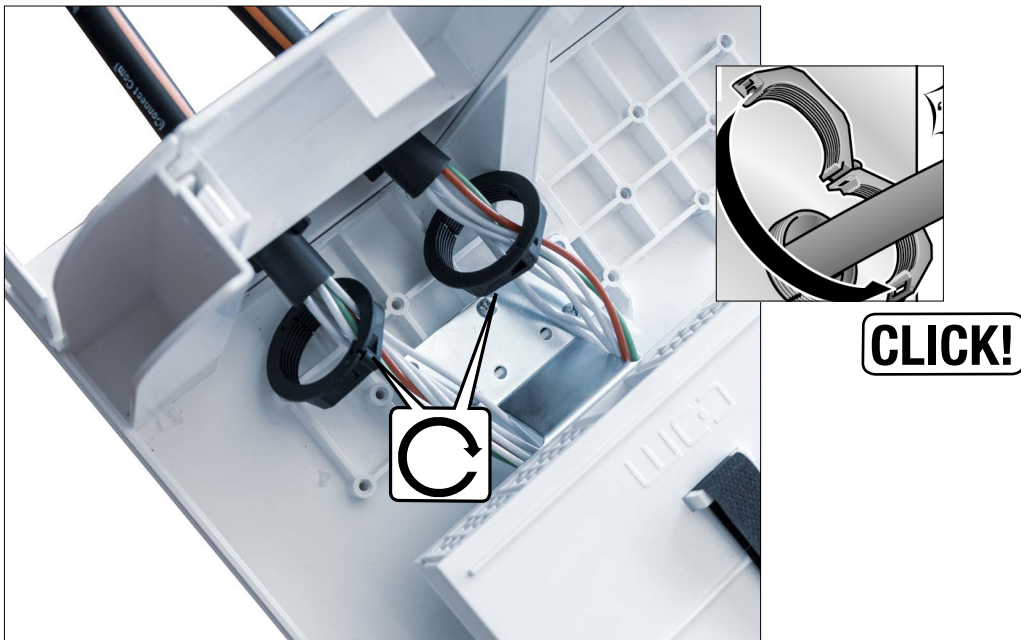
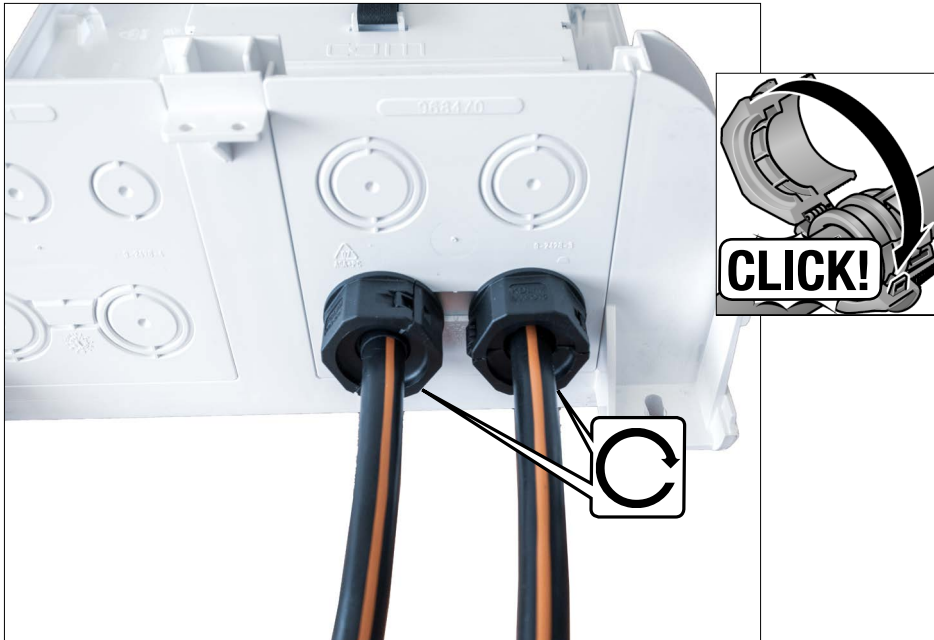

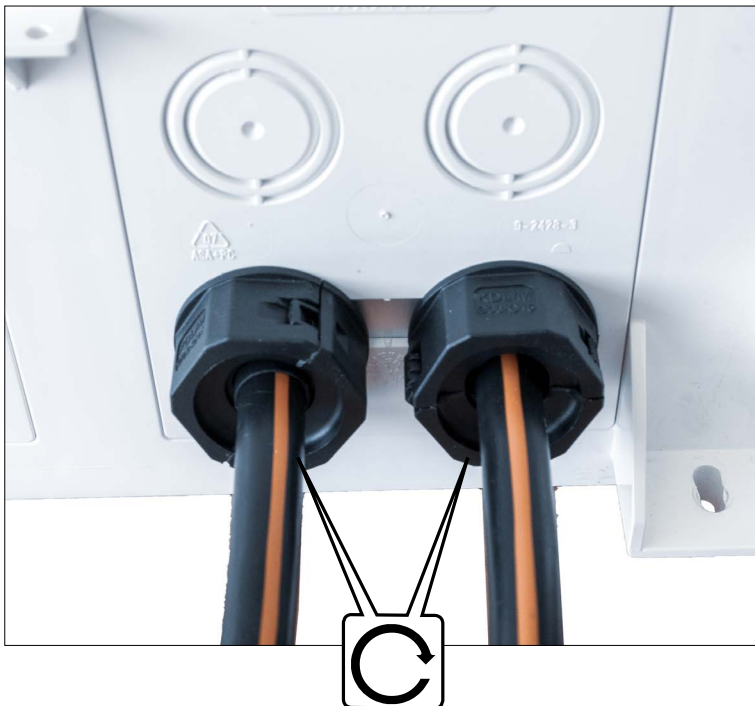
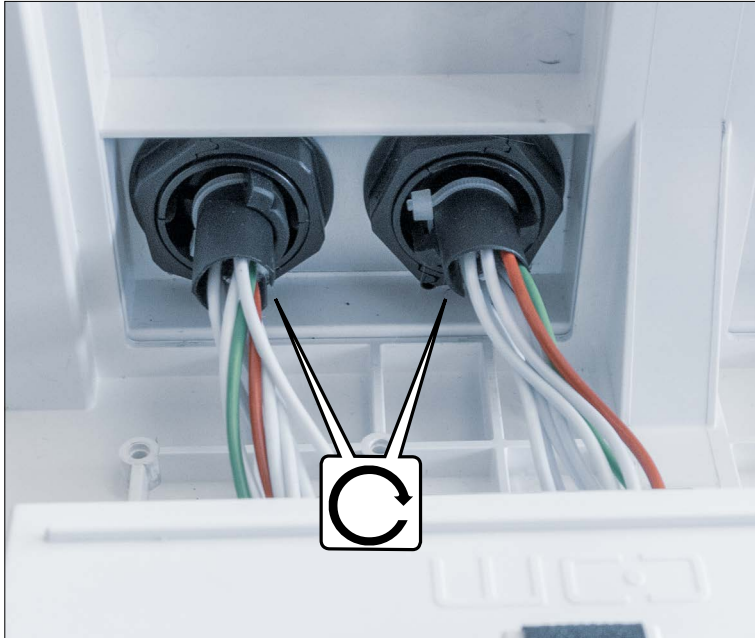

BELUGA PRO

